



SHADOW

108CT

APPLICATIONS

- Convention centers
- Athletic fields
- Stadiums
- Theme parks
- Swimming pools
- Cruise ships
- Malls
- Ballrooms
- Outdoor background music

KEY FEATURES

- 2-way multipurpose 8" coax
- Sturdy molded polyethylene curved enclosure
- 8" coaxial woofer with 2" coil
- 1" HF driver with 1.4" coil
- Line transformer
- 4 wires cable to select the power tapping
- IP55 weather resistant
- Standard grey finish
- Completely manufactured in Italy

ALL WEATHER LOUDSPEAKERS



Designed, Engineered
and Manufactured in ITALY

PRODUCT DESCRIPTION

The SHADOW 108CT is a weatherproof coaxial two way loudspeaker system offering substantial power and efficiency for a variety of professional indoor or outdoor applications. The low frequency transducer is a 8" woofer with a 2" voice coil. The high frequency section is a 1" driver with 1.4" voice coil on conical 90° horn. The SHADOW 108CT features a line transformer for 70-100V applications. The cabinet is a single piece rotational moulded in polyethylene, fully UV protected. The cabinet is equipped with a stainless steel U-bracket. The grille is in custom perforated stainless steel with 3 layers of protection. The SHADOW 108CT meets the requirements of IP55 code (International Protection

ELECTRONIC SPECIFICATIONS

System Type	2 Way
Recommended Amplifier	450W RMS
System Long Term Power	225W
System Short Term Power (IEC 268-5)	900W
Transformer (optional)	100V / 100W/50W
Nominal Impedance	8 Ohm
Frequency Response	80Hz - 20kHz (@-6dB)
Sensitivity	95dB (@1W, 1m)
Max SPL (cont/peak) (bi-amp)*	120dB / 124dB
Dispersion	90° conical
Crossover Frequency	1.8kHz
Recommended HP Filter	60Hz - 24dB oct.

PHYSICAL SPECIFICATIONS

Low Frequency Woofer	8" / 2" coil
High Frequency Driver	1" / 1.4" coil
Input Connectors	4 wire cable
Net Dimensions (WxHxD) inch	7.08 x 11.81 x 7.08
Shipping Dimensions (WxHxD) inch	11.22 x 11.22 x 9.84
Net Weight	15.4 lbs
Shipping Weight	19.8 lbs
Enclosure Material	Polyethylene rotomoulded
Grille	Custom perforated stainless steel

* CONT. SPL: free space, based on recommended amp rating and LF transducer average sensitivity data, 125mS time average
PEAK SPL: free space, based on short term applicable power rating and system peak sensitivity, 10mS time average



SHADOW

108CT

DIAGRAMS

Horizontal polar diagram

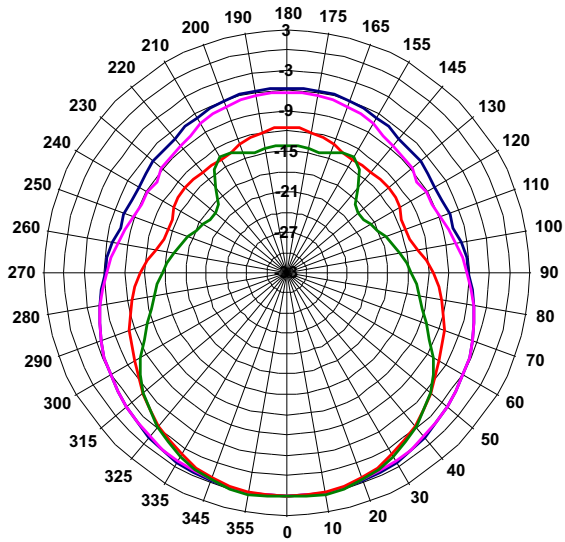
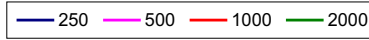

Horizontal polar diagram

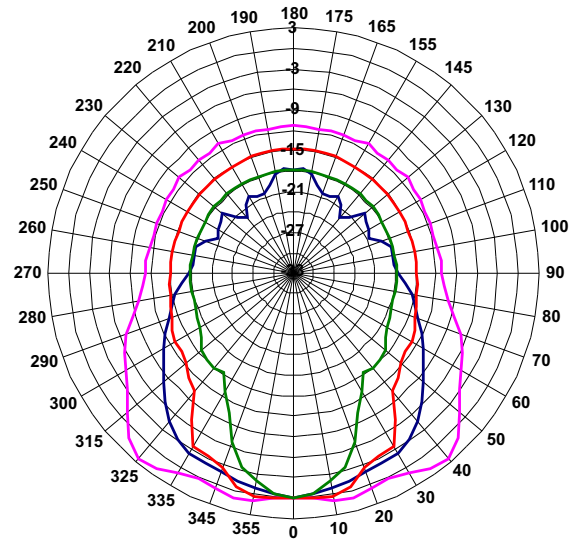
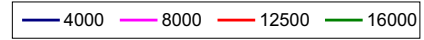

Horizontal coverage

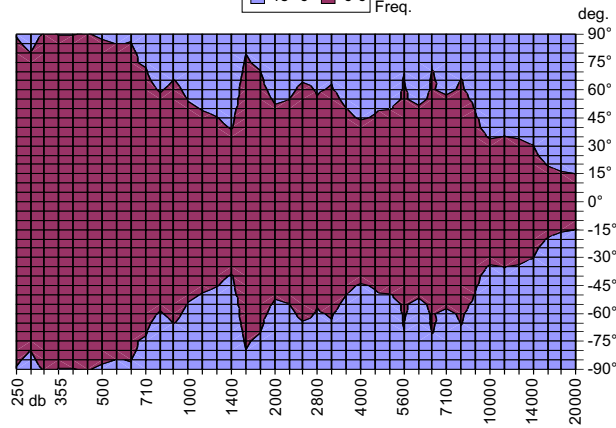
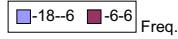

SPL vs Freq

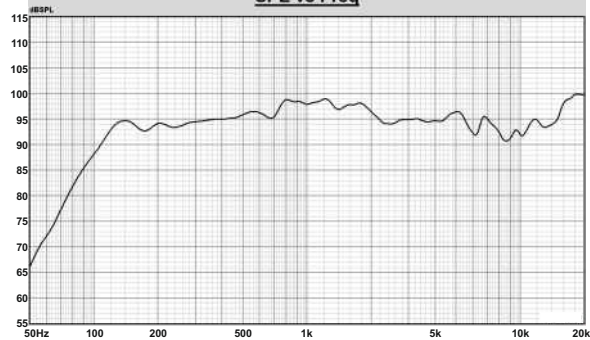



SHADOW

108CT

DIAGRAMS

Vertical polar diagram

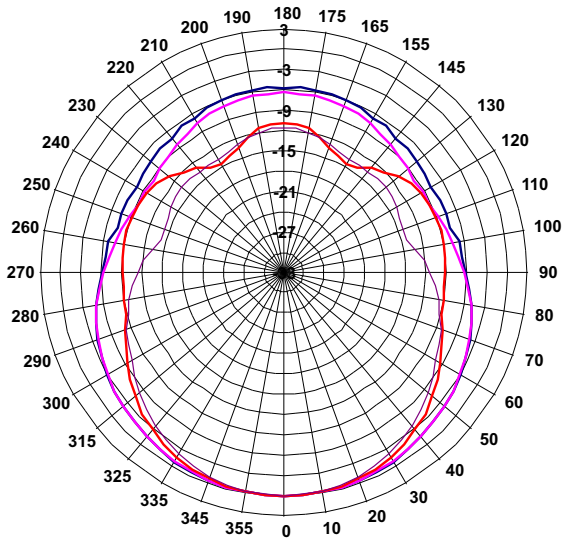
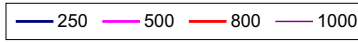

Vertical polar diagram

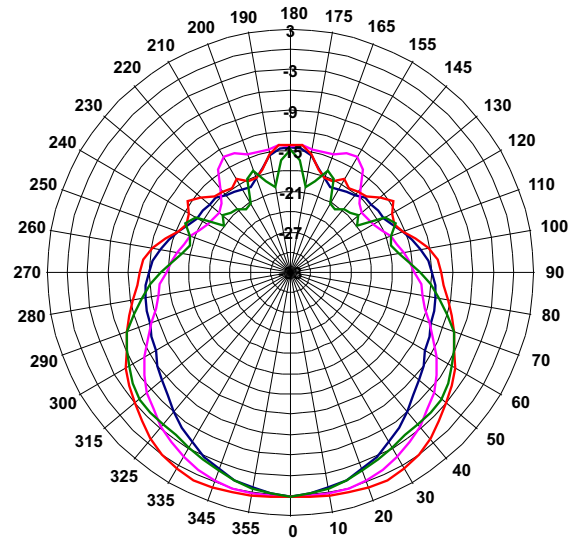
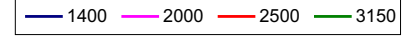

Vertical polar diagram

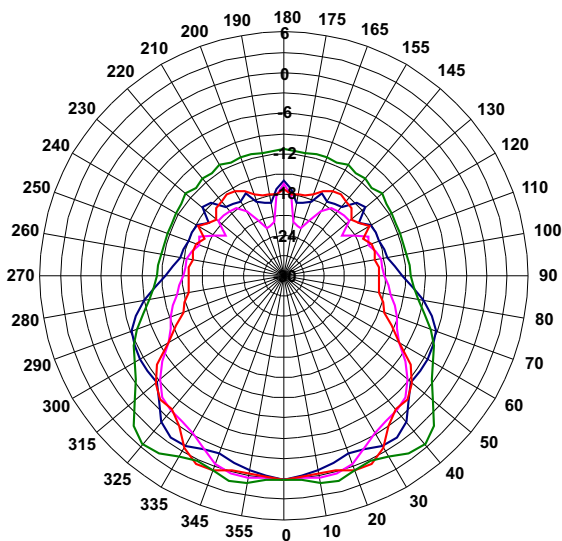
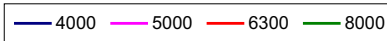

Vertical polar diagram

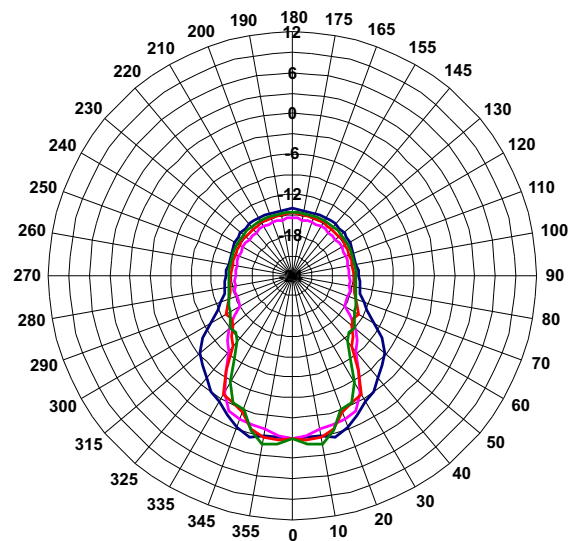
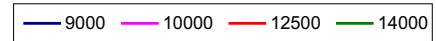

Vertical coverage





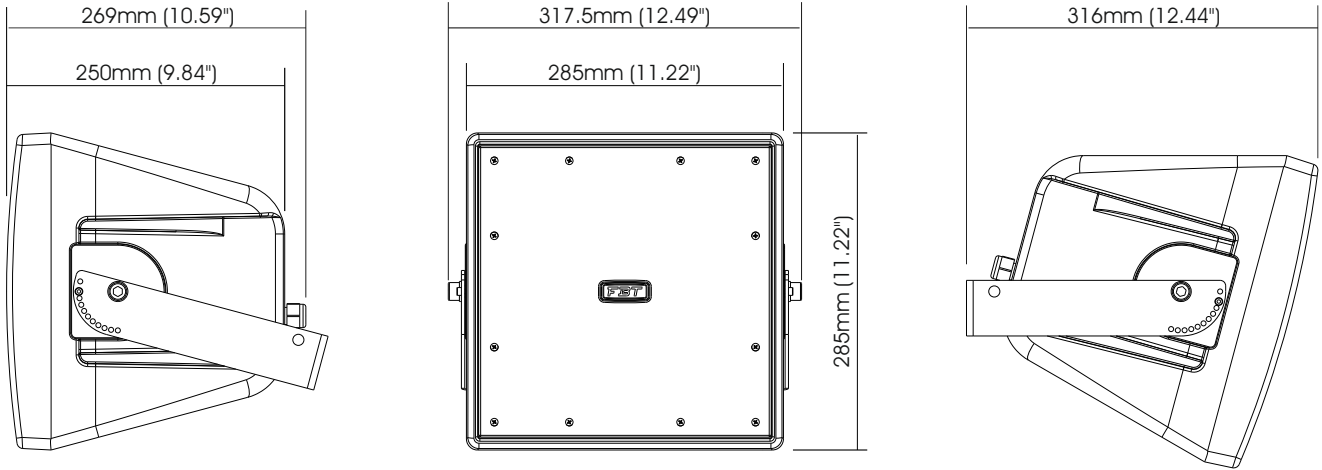

SHADOW 108CT

DIMENSIONAL DRAWINGS

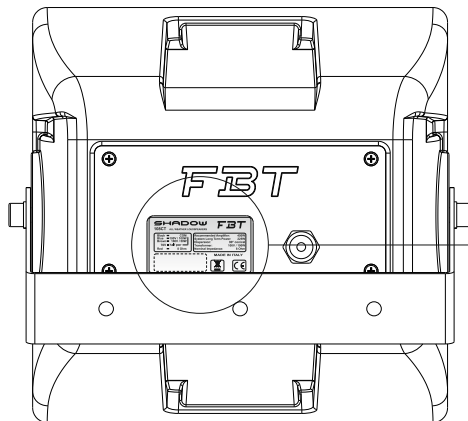

TECHNICAL SPECIFICATIONS LABEL



SHADOW FBT	
108CT ALL WEATHER LOUSPEAKERS	
Black - COM	Recommended Amplifier: 450W
Blue - 100V / 100W	System Long Term Power: 225W
Brown - 100V / 50W	Dispersion: 90° conical
70V = half pwr	Transformer: 100V / 100W
Red - 8 Ohm	Nominal Impedance: 8 Ohm
MADE IN ITALY	
 	

SUPPLIED ACCESSORY

